

AW.10.53

S H
2500 x 1200
2500 x 1450

kg 69
80

max. 3000 x 1750

System

Lux

H = 1450 : a = 290 , b = 290
H = 1200 : a = 290 , b = 290
H_{min} = 800

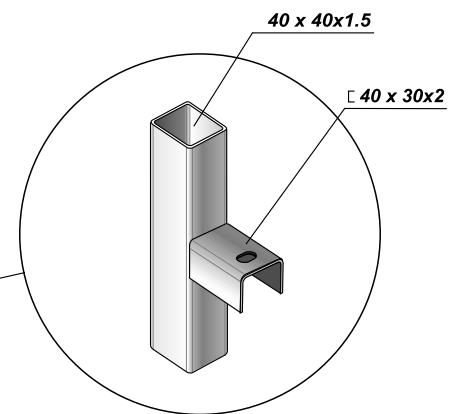
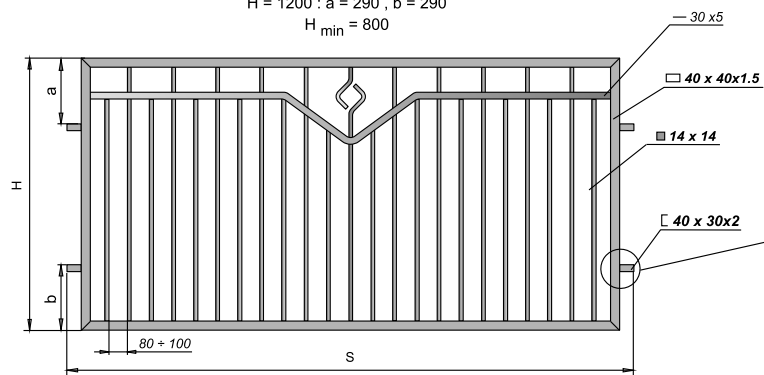

„R”

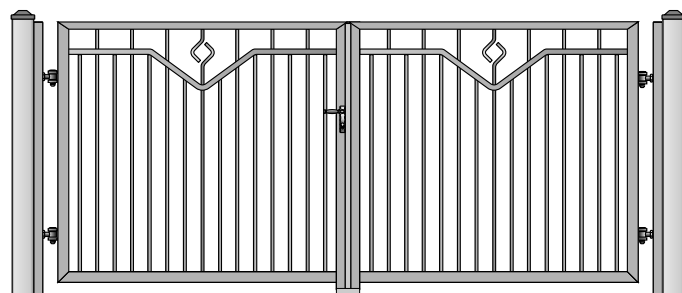

„A”

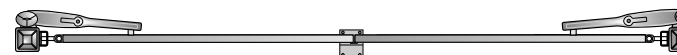
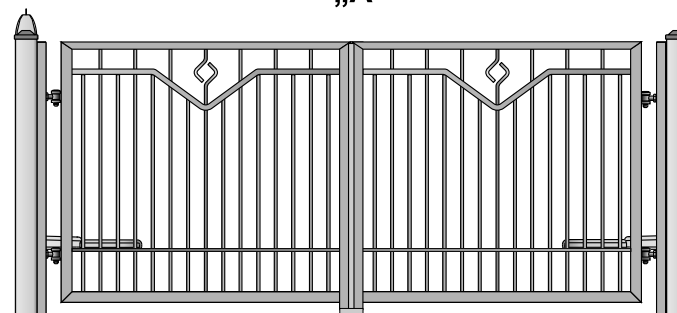

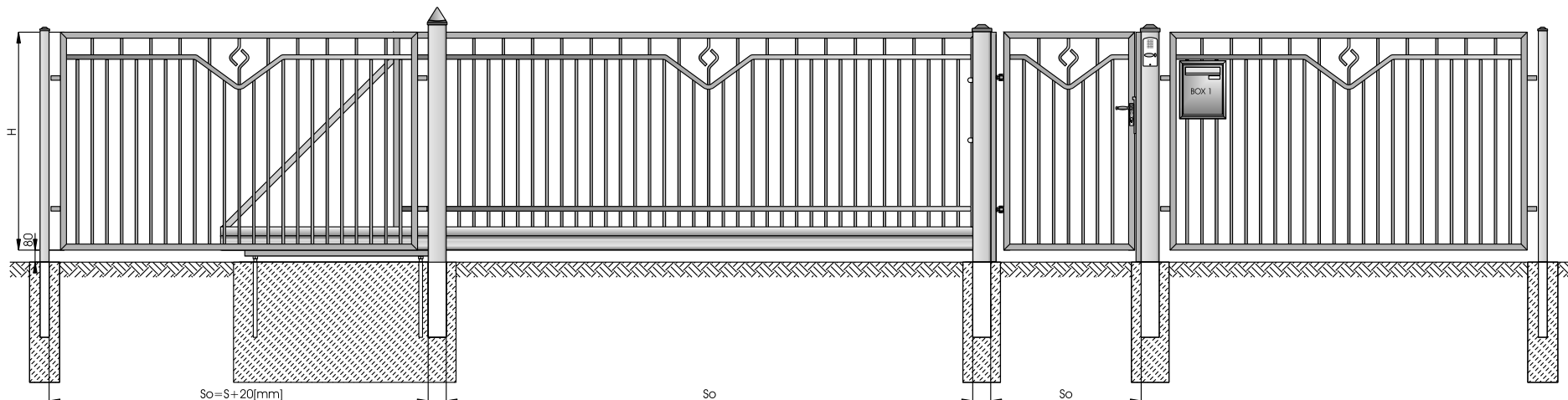

System Lux
RYS. L10.53P

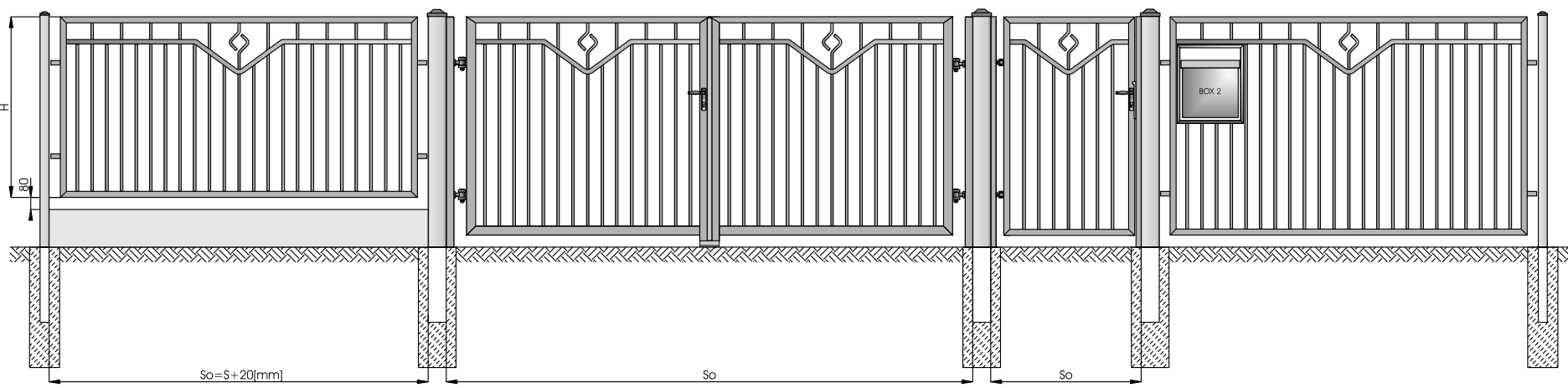

System Lux
RYS. L10.53D

