

AW.10.54

S H
2500 x 1200
2500 x 1450

kg 64
74

max. 3000 x 1750

System

Lux

H = 1450 : a = 290 , b = 290
H = 1200 : a = 290 , b = 290
H_{min} = 800

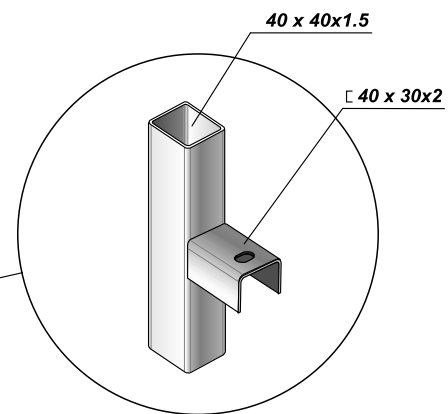
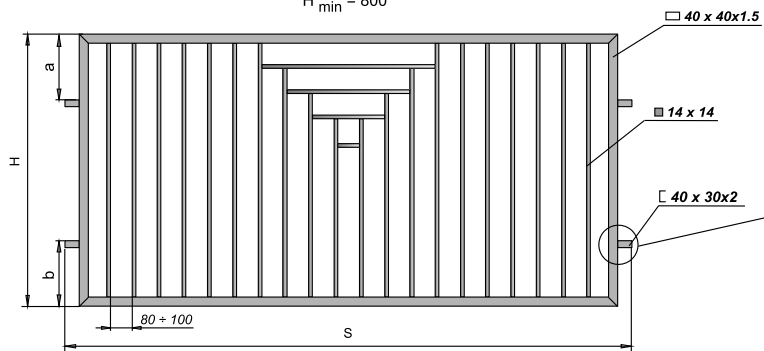

„R”

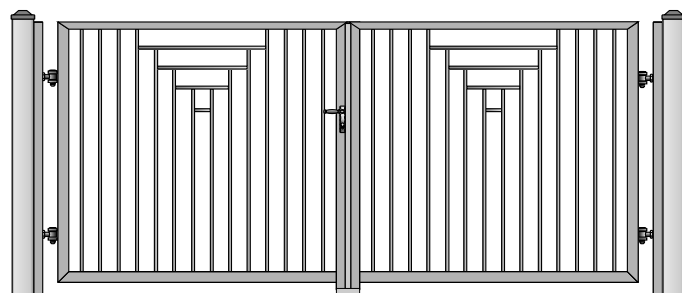

„A”

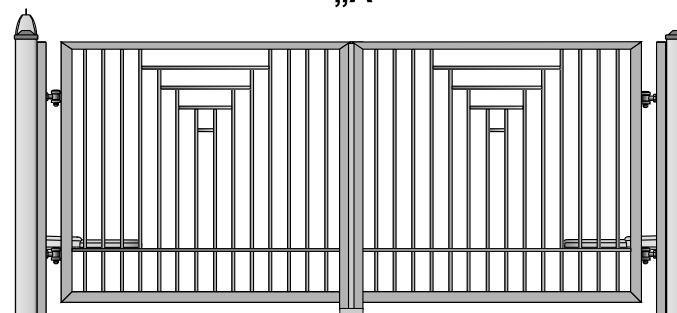

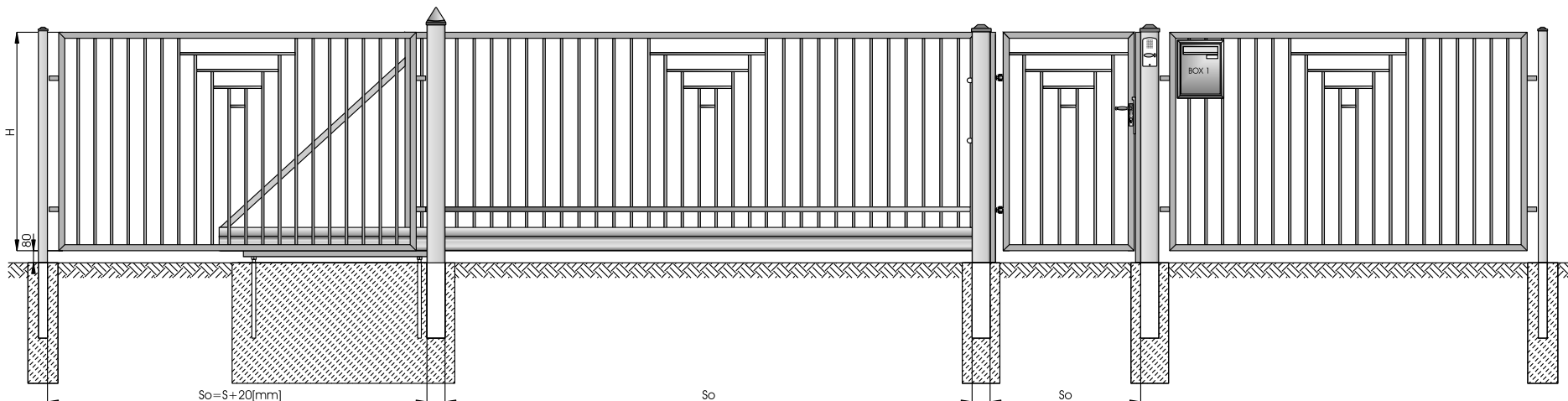

System Lux
RYS. L10.54P

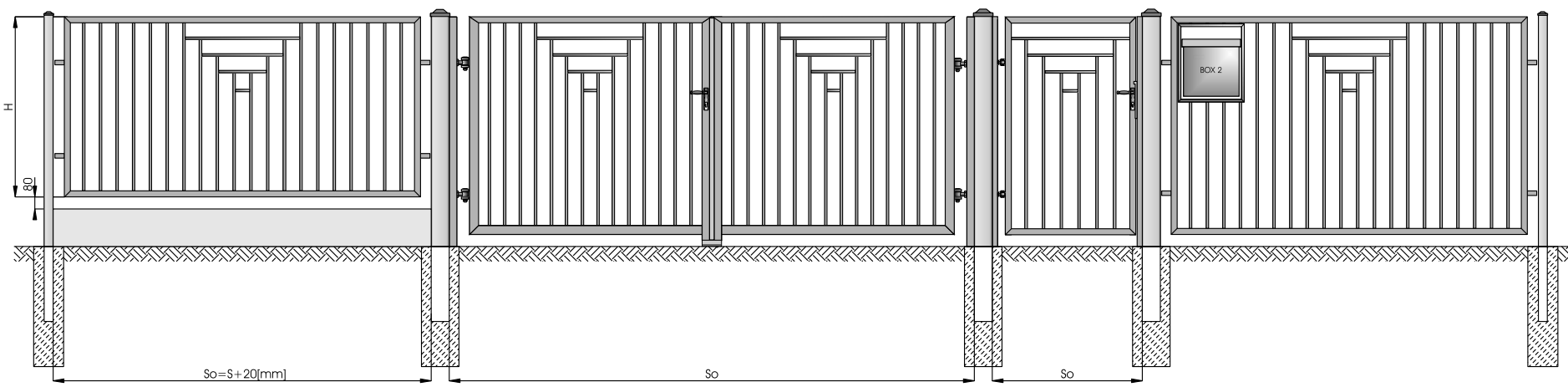

System Lux
RYS. L10.54D

